

Manual Motor Starters

to IEC 947 / EN 60947



Quality made in



D509E201

General Catalogue



Complete Assortment
Technical Datas
Dimensions
Applicationen
Distributors

Catalogue **D946E..**



Circuit Breakers



M4-32T.. up to 32A
M4-32R.. up to 32A
M4-63R.. up to 63A
M4-100R.. up to 100A

Catalogue **D795E..**



Switches



On-Off-Switches
Changeover Switches
Motor Switches
Step Switches
Main Switches
Modular Switches
Key Operated Switches

Catalogue **D371E..**



Main Switches



Emergency Off
Main Switches
On-Off-Switches
Add-On-Module

Catalogue **D656E..**



Capacitor Switching Contactors



Contactors for reactive and non reactive capacitor banks

Catalogue **D385E..**



Manual Motorstarter



MU25A up to 32A
Auxiliary Contact Blocks
Trip Alarm Auxiliary Switches
Busbar Connectors
Enclosure

Catalogue **D509E..**



Push Buttons



Push Buttons
Emergency Stop
Key Operated Rotary Switches
Rotary Knobs
Illuminated Push Buttons
Assembled Stations

Catalogue **D580E..**



Modular Contactors



Modular Contactors
Accessories
Emergency Off Switches
Main Switches
On-Off Switches
Control Switches

Catalogue **D681E..**



DC-Switchgear for Photovoltaic



Main Switches
On-Off-Switches
Contactors for DC-Switching

Catalogue **D911E..**



Contactors Motor-Starter



Mini-Contactors
Contactors
Overload Relays
Capacitor Switching
Contactors
Motor-Starters
Modular Contactors

Catalogue **D677E..**





Manual Motors Starters

4



Auxilliary Contact Blocks

4



Shunt Release

4



Under-voltage Release

5



Accessories

5



Busbar Connectors

5



Enclosures

5



Technical Data

6



Dimensions

7

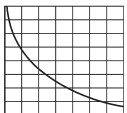

Tripping Characteristic

7

Manual Motor Starters



Thermal Overload Release Setting Range A	Ratings AC3 at 400V kW		690V kW	Magnetic short circuit trip A	Type	Pack pcs.	Weight kg/pc.
	0,16 - 0,25	0,06 - 0,09					
0,16 - 0,25	0,06 - 0,09	0,12 - 0,18		3,75 - 6	MU25-0,25 MU25-0,4	1 1	0,25 0,25
0,4 - 0,63	0,12 - 0,15	0,25 - 0,55		7,45 - 15	MU25-0,63 MU25-1	1 1	0,25 0,25
1 - 1,6	0,25 - 0,55	1,1		24	MU25-1,6	1	0,25
1,6 - 2,5	0,75 - 1,5	1,5 - 3		37,50 - 60	MU25-2,5 MU25-4	1 1	0,25 0,25
2,5 - 4	1,5 - 2,5	4		94,50	MU25-6,3	1	0,25
6,3 - 10	4 - 7,5	7,5 - 11		150 - 240	MU25-10 MU25-16	1 1	0,25 0,25
10 - 16	7,5 - 9	12		300	MU25-20	1	0,25
20 - 25	12,5 - 15	22		375 - 480	MU25-25 MU25-32	1 1	0,25 0,25

Auxiliary Contact Blocks, for side mounting, max. 2 pieces



Contacts				Rated Operational Current AC15 230V			Type	Pack pcs.	Weight kg/pc.
NO	NC	EM ¹⁾	400V A	AC1 500V A					
1	1	-	3,5	2	6	MU25-PS11	10	0,03	

System MU25

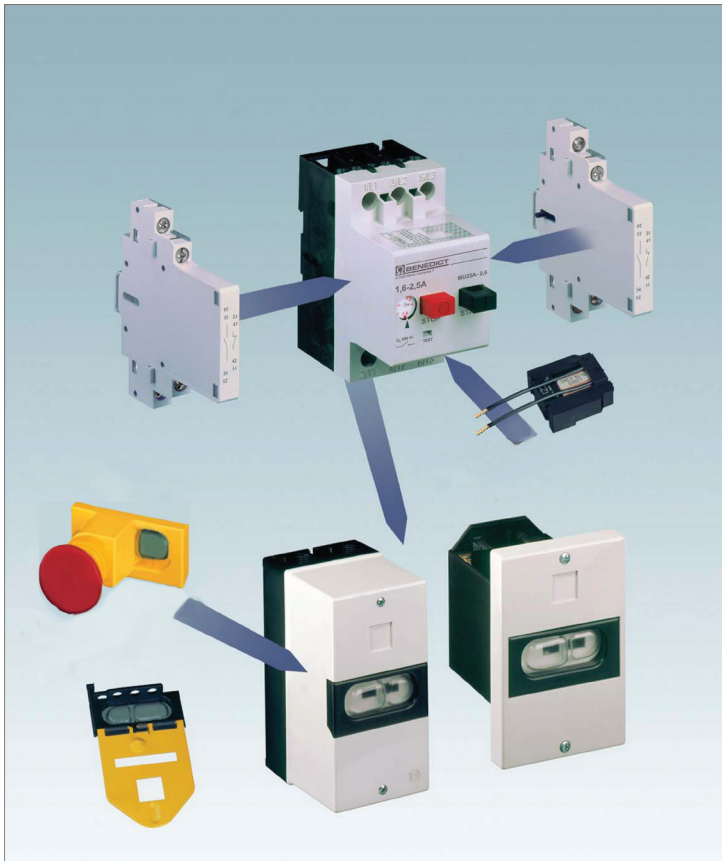

Approvals

Country	USA, Canada UL	Europe
Type		

Shunt Release for mounting under the cover



Rated Control Voltage and Frequency V	Power Consumption		Type	Pack pcs.	Weight kg/pc.
	VA	W			
110V 50Hz, 110-120V 60Hz	2,7	1,8	MU25-A110	10	0,06
220-230V 50Hz, 240V 60Hz	2,7	1,8	MU25-A230	10	0,06

Under-voltage Release for mounting under the cover



Rated Control Voltage and Frequency V	Power Consumption		Type	Pack pcs.	Weight kg/pc.
	VA	W			
110V 50Hz, 110-120V 60Hz	2,7	1,8	MU25-U110	10	0,06
220-230V 50Hz, 240V 60Hz	2,7	1,8	MU25-U230	10	0,06
380-415V 50Hz, 440V 60Hz	2,7	1,8	MU25-U400	10	0,06

Accessories



Description	Specification	Type	Pack pcs.	Weight kg/pc.
Busbar Connector Fully Isolated, Ui 690V, Iu 63A				
Busbar	for 2 units, 99mm long	MU25A-D99	10	0,036
Busbar	for 3 units, 154mm long	MU25A-D154	10	0,060
Busbar	for 4 units, 208mm long	MU25A-D208	10	0,084
Busbar	for 5 units, 262mm long	MU25A-D262	10	0,107
Supply Block	3-pole for use with busbar connector	MU25A-DB	10	0,034
Spacing piece 1/2TE	for ambient temperature >40°C	P730	10	0,013
Enclosures				
Moulded Enclosure	Protection to IP55	MU25-O55	1	0,24
Moulded Front Plate	Protection to IP55	MU25-C55	1	0,16
Locking Bracket	Suitable for 3 padlocks in "OFF"-position, stirrup diameter of the padlock max. 8 mm	MU25-Z	1	0,1
Emergency Stop Button	latch, release by turning	MU25-NAV	1	0,04

Manual Motor Starters

Data according to IEC 947, IEC 204, EN 60947, EN 60204, VDE 0660, VDE 0113

Type	MU25			
Main Contacts				
Rated insulation voltage U_i	V~ ¹⁾	690		
Rated operational current I_e (=Ith) open, at 50°C	A	25 ²⁾		
Mechanical life	S x 10 ⁶	0,1		
Contact life at I_e /AC3	S x 10 ⁶	0,1		
Tripping class according to IEC 60947-4-1		10A		
Rated ultimate short-circuit breaking capacity I_{cu}		220-240V~	380-415V~	500V~ 660-690V~
Values for open unit, when incoming supply on upper terminals				
Setting range	bis 1A kA	50	50	50 50
	1 - 1,6A kA	50	50	50 50
	1,6 - 2,5A kA	50	50	3 2,5
	2,5 - 4A kA	50	50	3 2,5
	4 - 6,3A kA	50	50	3 2,5
	6,3 - 10A kA	50	6	3 2,5
	10 - 16A kA	10	6	2,5 2
	16 - 20A kA	10	6	2,5 2
	20 - 25A kA	10	6	2,5 2
	25 - 32A kA	10	6	2,5 2
Short circuit protection		220-240V~	380-415V~	500V~ 660-690V~
Setting range	bis 1A A	-	-	- -
	1 - 1,6A A	-	-	- -
Fuse gL(gG) only necessary if the short circuit current could be greater than the rated ultimate short-circuit breaking capacity	1,6 - 2,5A A	-	-	25 20
	2,5 - 4A A	-	-	35 25
	4 - 6,3A A	-	-	50 35
	6,3 - 10A A	-	80	50 35
	10 - 16A A	80	80	63 35
	16 - 20A A	80	80	63 50
	20 - 25A A	80	80	63 50
	25 - 32A A	80	80	63 50
Maximum ambient temperature Operation	open °C	-25 bis +60		
	enclose °C	-25 bis +40		
Temperature compensation	°C	-5 bis +40		
Storage	°C	-25 bis +70		
Power loss at rated current, warm condition	W	6 - 8		
Auxiliary Contacts				
Rated insulation voltage U_i	V~	500		
Thermal rated current Ith Ambient temperature max. 50°C	A	6		
Utilization category AC15				
Rated operational current I_e	220-240V A	3,5		
	380-415V A	2		
	500V A	1,5		
Short circuit protection max. fuse size	gL (gG) A	6		
Cable cross-section				
Main connector	solid or stranded mm ²	1 - 6		
	flexible mm ²	1 - 4		
	flexible with multicore cable end mm ²	0,75 - 4		
Number of clampable conductors per terminal / Screw torque		2 / M3 - Pz2 1,8Nm		
Auxiliary connector	solid or stranded mm ²	0,75 - 2,5		
	flexible mm ²	0,75 - 1,5		
	flexible with multicore cable end mm ²	0,75 - 1,5		
Number of clampable conductors per terminal / Screw torque		2 / M3,5 - Pz1 1Nm		
Resistance to shock according to IEC 68-2-27	g	20		
vibration resistance to IEC68-2-6	g	5 (by f= 5...150Hz)		

1) Suitable for: earthed-neutral systems, overvoltage category I to III, pollution degree 3 (standard-industry): $U_{imp} = 6kV$.

2) Maximum number without gap: 3

Manual Motor Starters

Maße

Manual Motor Starter
MU25

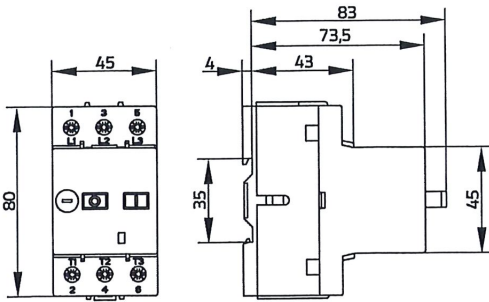

Moulded Enclosure
MU25-O55

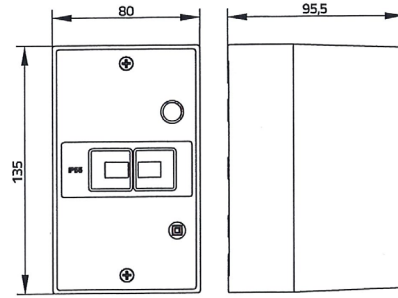

Moulded Front Plate
MU25-C55

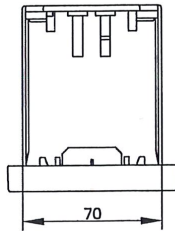
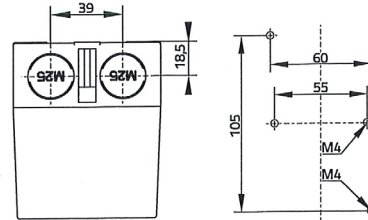
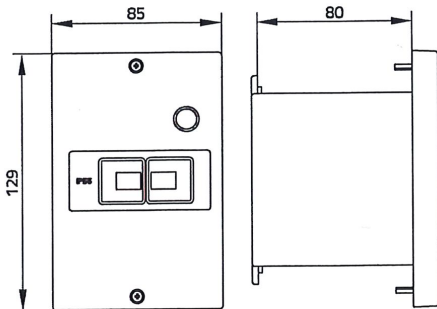

Mounting
with clamps

with screws

Temperature Compensation

In case of higher ambient temperature use the following formula: $(\text{Ambient temperature} - 20) \times 0,3 = \text{correction factor in \% of the full load motor current}$

Example:

Ambient temperature 60°C, full load motor current 5A
 $(60 - 20) \times 0,3 = 12\%$

Tripping Characteristic

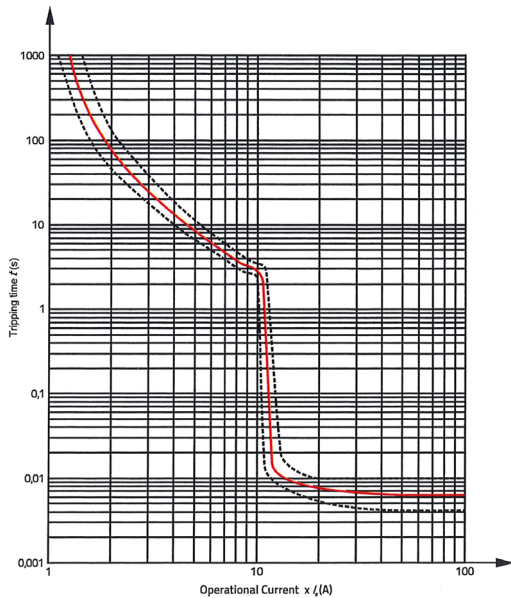

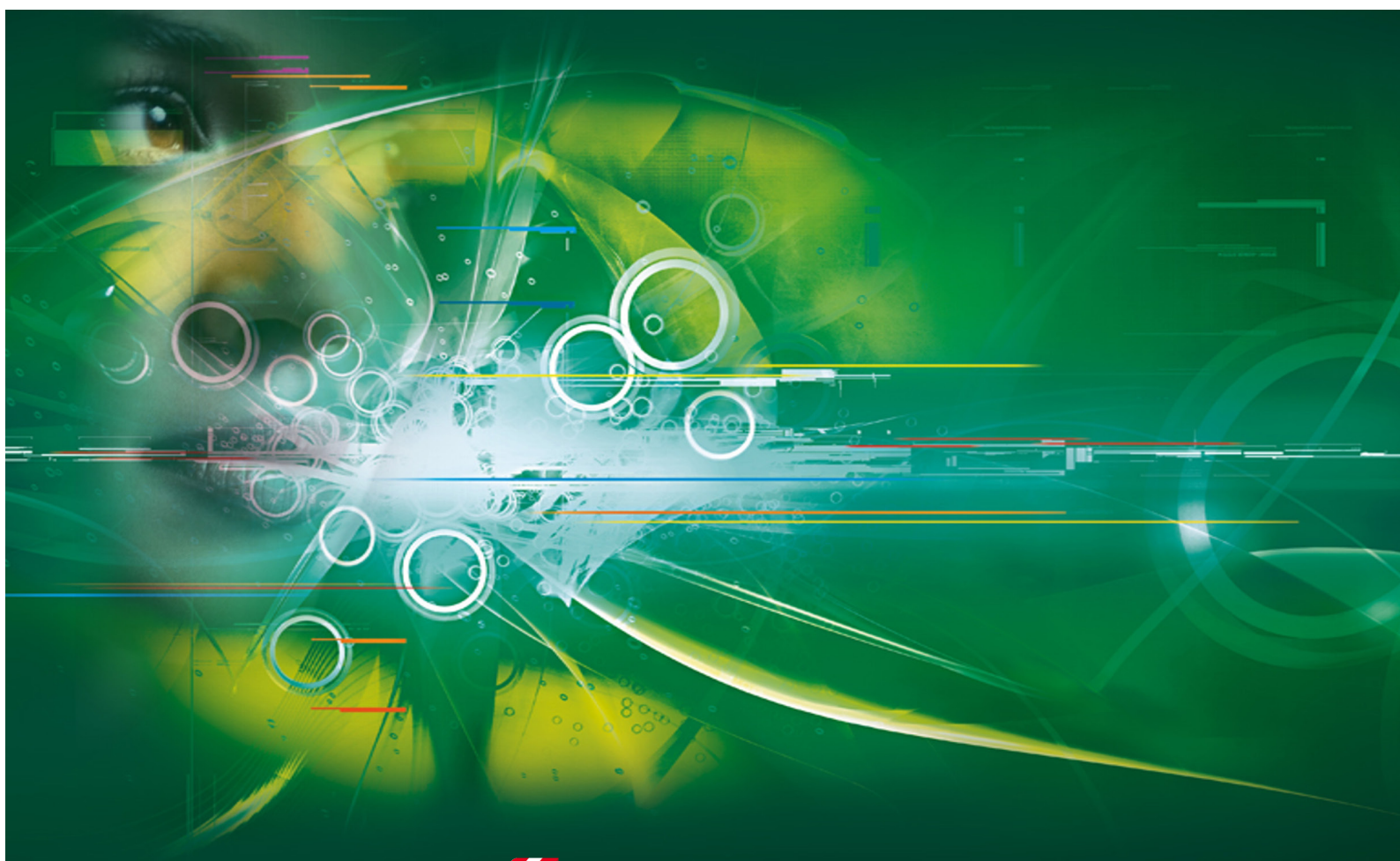

Quality made in 

D509E201



Lieblgasse 7, A-1220 Wien
Telefon: +43 1 251 51- 0
Fax: +43 1 251 51-89
e-mail: sales@benedict.at
www.benedict.at

